

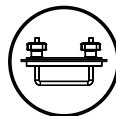

ciao



---

All the pleasure of travelling

---

## Montageanleitung | Installation instruction

Istruzioni di montaggio | Instructions de montage | Montage-instructies | Instrucciones de montaje | Instruções de montagem | Monteringsanvisning  
Asennusohje | Paigaldusjuhend | Stiprinašanas instrukcija | Pritvirtinimo instrukcijos | Instrukcja montażu | Navod na montaz | Montaj talimatları

A

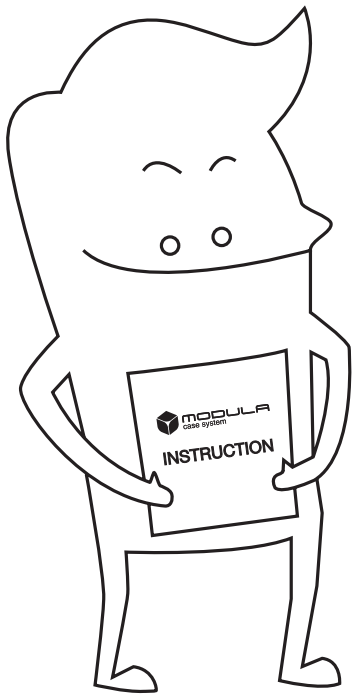

B

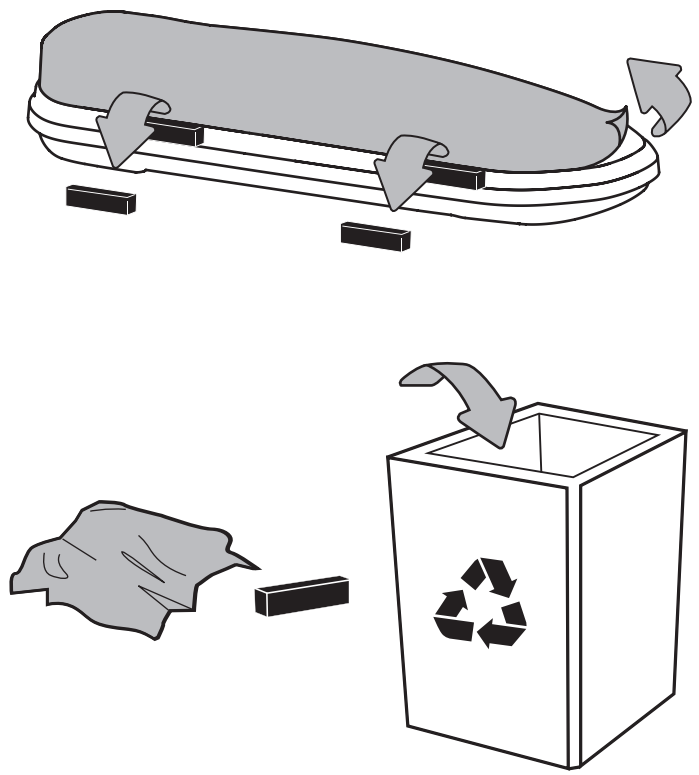

C

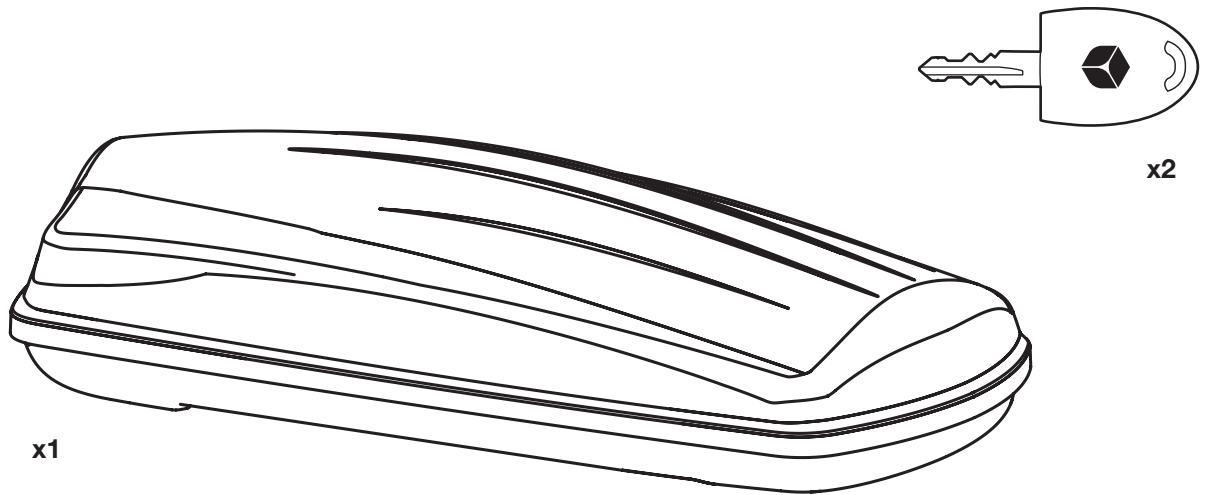

1

310 28 MIN | 79 cm MAX  
340 19 MIN | 78 cm MAX  
430 41 MIN | 98 cm MAX  
580 60 MIN | 125 cm MAX

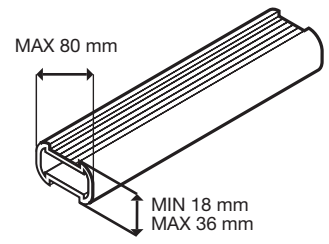
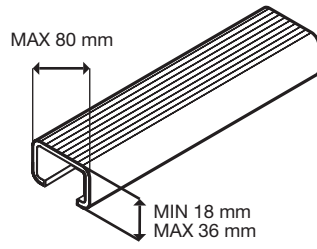
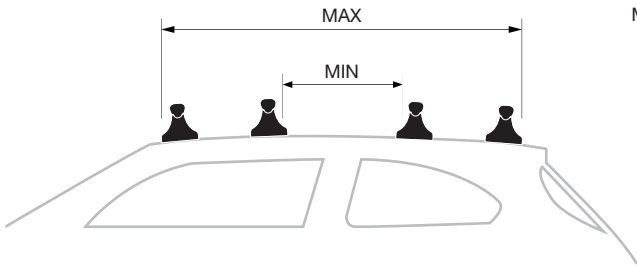

2

2.1

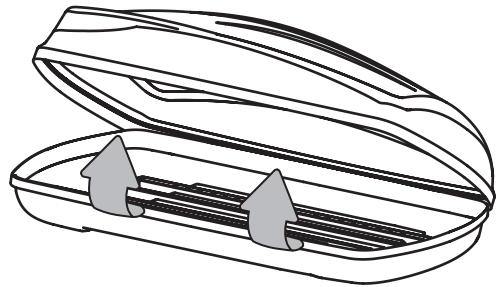
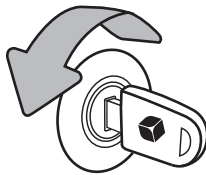
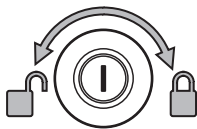

2.2

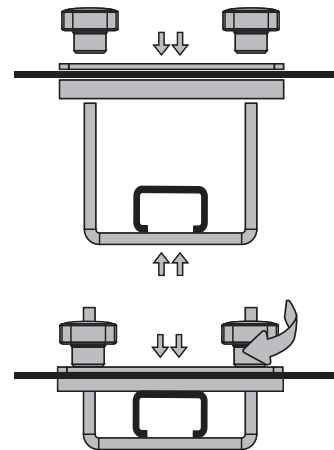
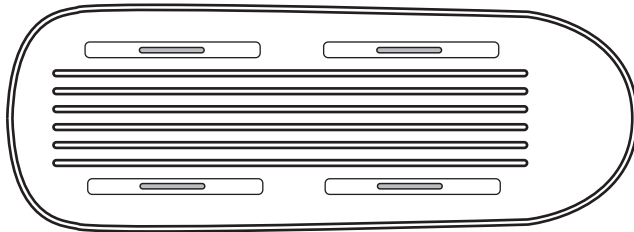
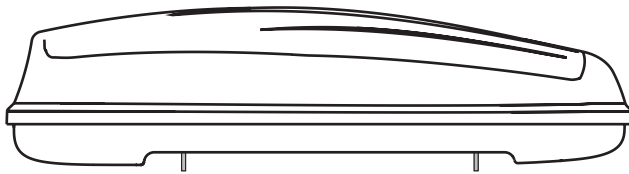

2.3

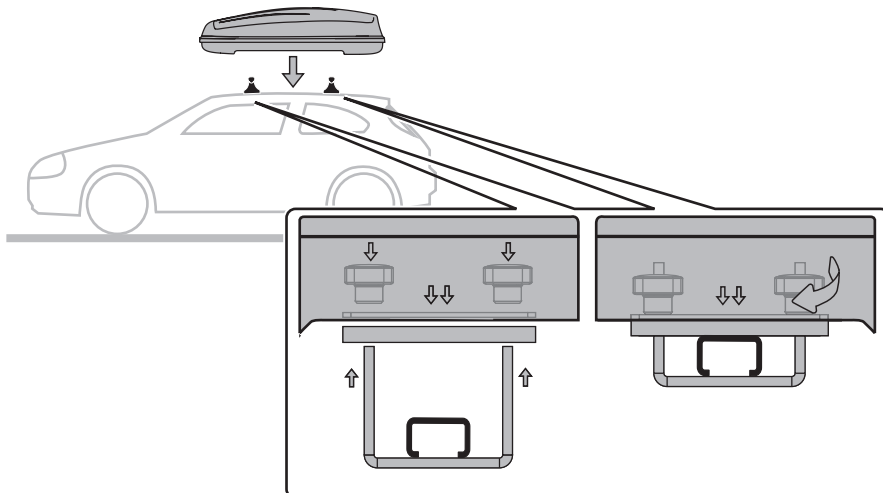

YES

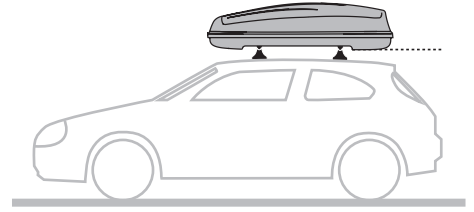
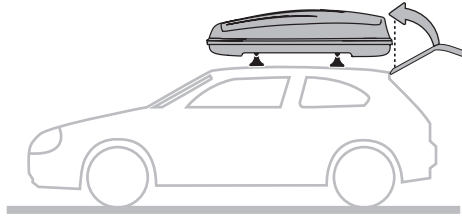
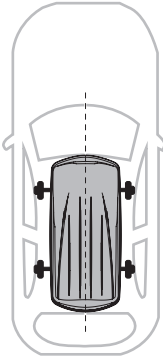

NO

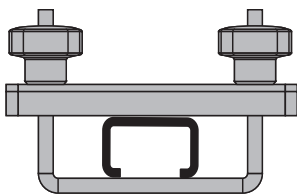
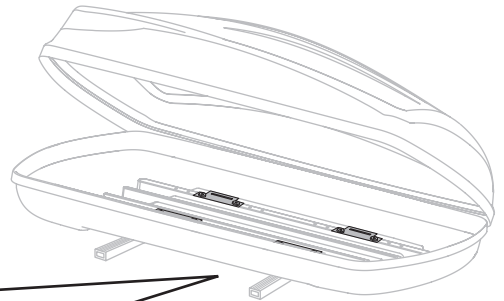
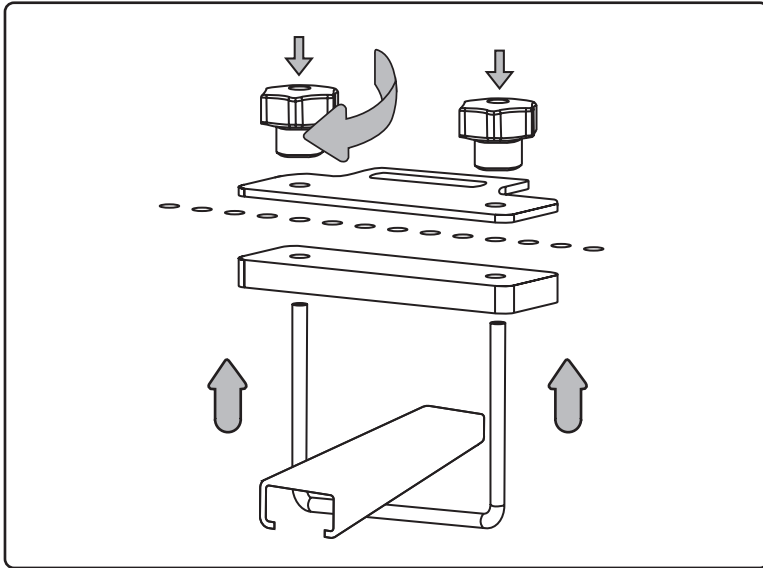
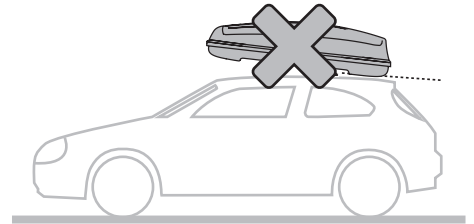
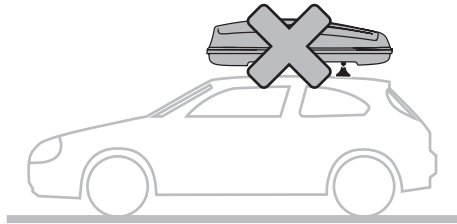
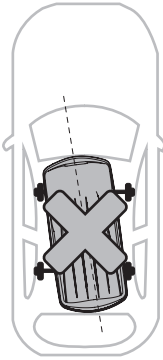

YES

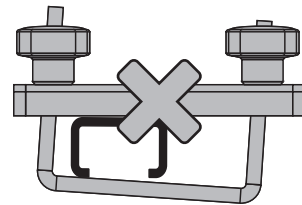

NO

4.1

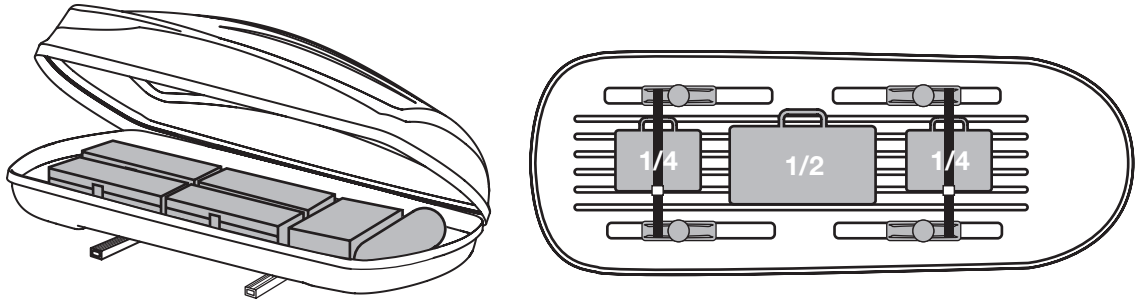

4.2

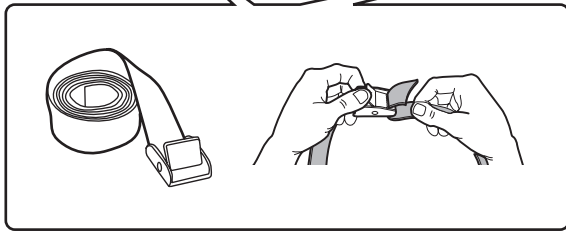
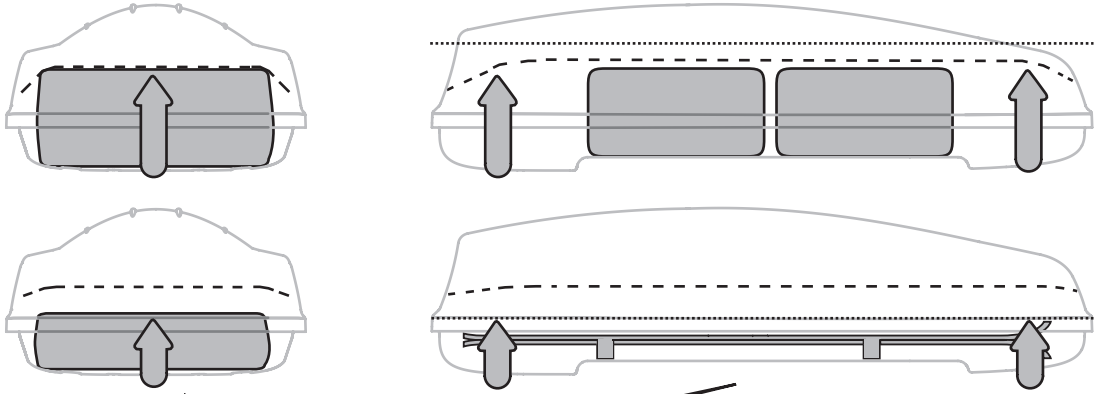

NO

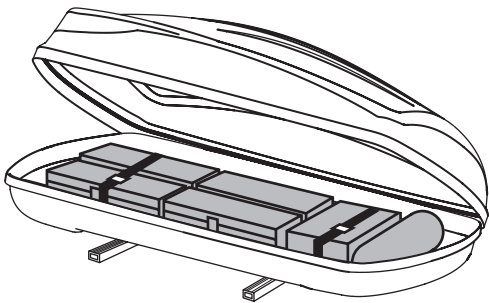
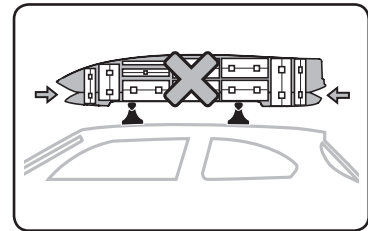

YES

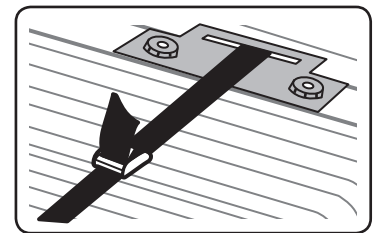

YES

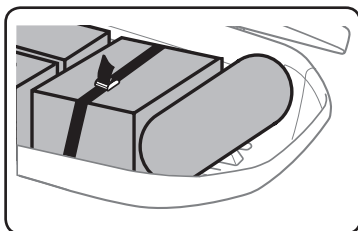

NO

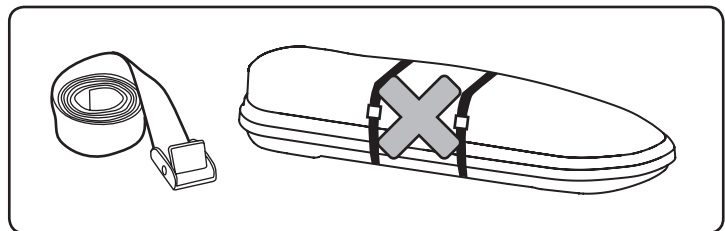

6

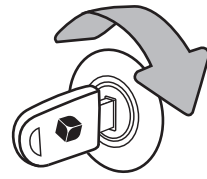
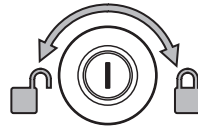
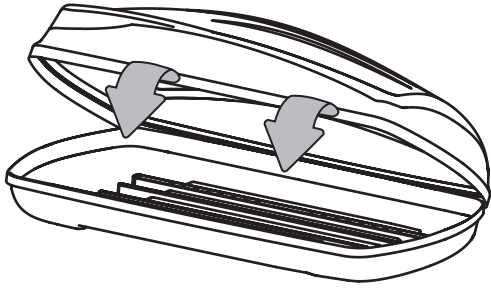

7

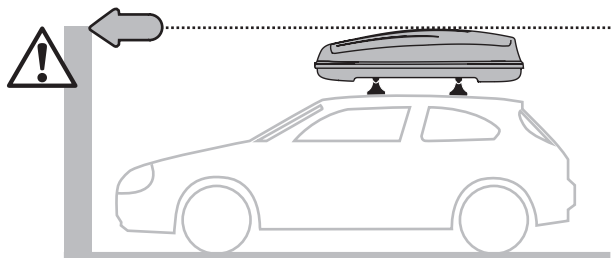
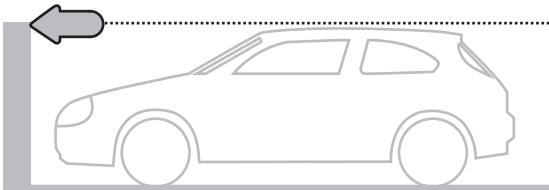

8

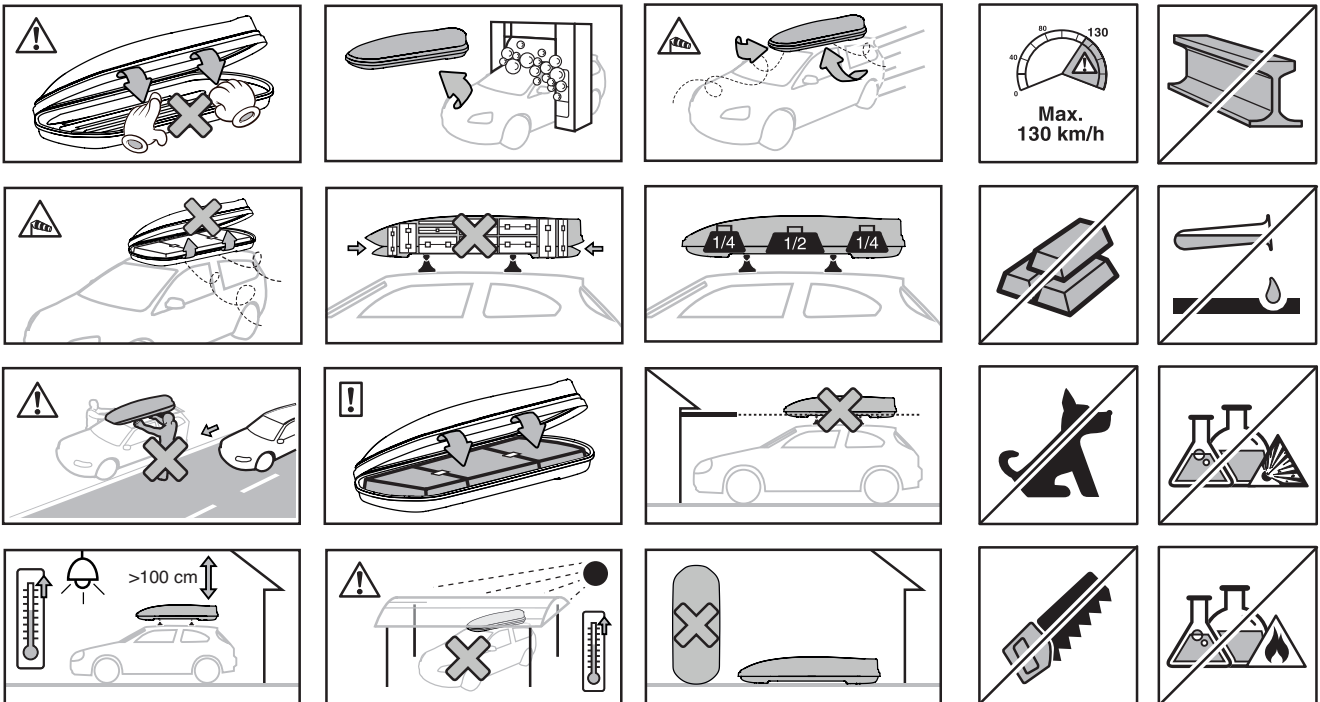

## CIAO 310

Größe/Dimensions **L 126 W 78 H 35 cm** | Volumen/Volume **310 liter** | Zuladung/Capacity **75 kg** | Gewicht/Weight **7,4 kg**

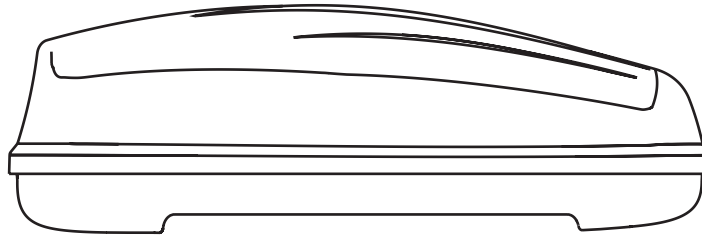

## CIAO 340

Größe/Dimensions **L 140 W 80 H 44 cm** | Volumen/Volume **340 liter** | Zuladung/Capacity **75 kg** | Gewicht/Weight **11 kg**

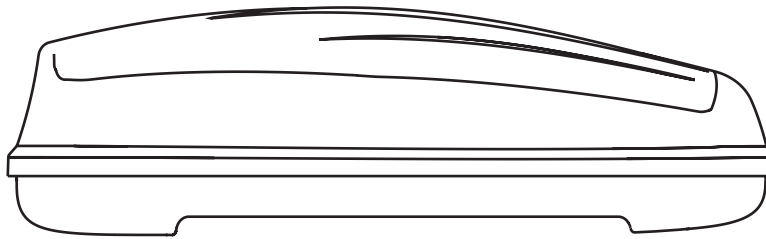

## CIAO 430

Größe/Dimensions **L 175 W 80 H 44 cm** | Volumen/Volume **430 liter** | Zuladung/Capacity **75 kg** | Gewicht/Weight **12,4 kg**

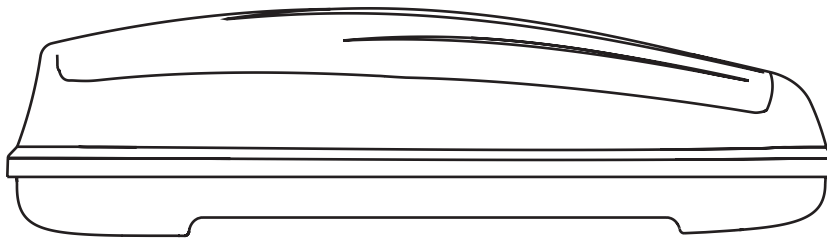

## CIAO 580

Größe/Dimensions **L 220 W 92 H 44 cm** | Volumen/Volume **580 liter** | Zuladung/Capacity **75 kg** | Gewicht/Weight **20 kg**

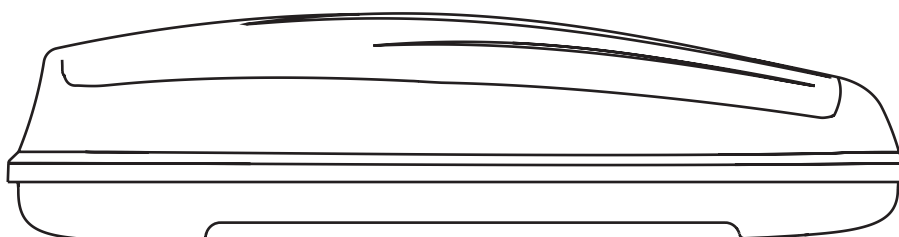

**Sicherheitsvoraussetzungen und Empfehlungen:**

Nach einer anfänglichen kurzen Reise und in regelmäßigen Zeitabständen, je nach Straßenkondition, müssen die Anschlussverschraubungen und, ins besondere, die Befestigungen des Dachkoffers kontrolliert werden.

Das Fahrverhalten des Fahrzeugs (Seitenwindgefährdung, Kurvenfahrt und Bremsverhalten) kann sich ändern wenn der Dachkoffer montiert ist, besonders wenn geladen.

Für die Sicherheit der anderen Verkehrsteilnehmer und für Energie-spargründe, sollte der Dachkoffer, bei Nichtgebrauch, abgenommen werden.

Die Informationen des Fahrzeugherstellers, bezüglich der zulässigen Dachladung, müssen befolgt werden.

Die zulässige Dachladung ist eine Kombination des Gewichts des Dachkoffers, Dachträger und tatsächlichen Ladung.

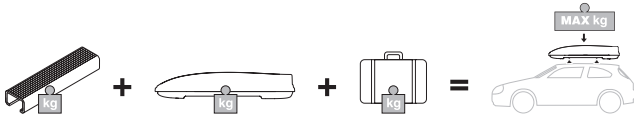

Der Dachkoffer muss in Fahrrichtung montiert werden ohne positive Einfallswinkel, um erhöhte Hebekräfte zu vermeiden.

**Achtung:**

Es ist äußerst wichtig die Montage und Gebrauchsanweisungen korrekterweise zu folgen.

Befestigen und kontrollieren Sie die Befestigungsbaugruppen regelmäßig während der Reise.

Bewahren Sie diese Gebrauchsanleitung sicher auf.

Verstauen Sie die Ladung auf sichere und korrekte Weise.

Es ist wichtig die Ausrüstungen in einem guten betriebsfähigen Zustand zu erhalten.

**Requirements and recommendations:**

After a short travel at first and specific time periods, depending on the road conditions, the bolt connections and the roof container fixing have to be checked.

The driving behavior of the vehicle changes (vulnerability to side winds, cornering and breaking behavior) when the roof container is mounted, especially when loaded.

By reasons of safety of other traffic participants and for matters of energy saving, the roof container should be taken off during periods of no use.

The information stated by the vehicle's manufacturer, concerning the permissible roof load, has to be followed.

Consider the weight of the container, since permissible roof load is a combination of the actual load, adding the weight of the roof racks and container.

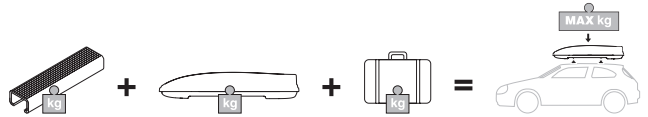

The roof container has to be mounted in direction of the travel without a positive angle of incidence, to avoid any increase in lifting forces.

**Warning:**

It is very important to follow the instructions of fitting and use;

Tighten and check the fixing devices correctly and regularly during travel;

Keep this instruction manual safely;

Secure the roof container load correctly and safe;

It is important to maintain the equipment in good working order.



Brand of Modula srl  
 Loc. Penisola 20/A  
 61026 Piandimeleto (PU) Italy  
 P +39 0722700070  
 F +39 0722 720017  
 W www.modulacs.com  
 E info@modulacs.com

*Design and manufactured made in Italy*

COCS090205

